



# EthernetBlaster II Communications Cable

---

## User Guide



101 Innovation Drive  
San Jose, CA 95134  
[www.altera.com](http://www.altera.com)

UG-01079-1.0  
P25-36448-00

Document last updated for Altera Complete Design Suite version:  
Document publication date:

10.0  
August 2010



[Subscribe](#)

© 2010 Altera Corporation. All rights reserved. ALTERA, ARRIA, CYCLONE, HARDCOPY, MAX, MEGACORE, NIOS, QUARTUS and STRATIX are Reg. U.S. Pat. & Tm. Off. and/or trademarks of Altera Corporation in the U.S. and other countries. All other trademarks and service marks are the property of their respective holders as described at [www.altera.com/common/legal.html](http://www.altera.com/common/legal.html). Altera warrants performance of its semiconductor products to current specifications in accordance with Altera's standard warranty, but reserves the right to make changes to any products and services at any time without notice. Altera assumes no responsibility or liability arising out of the application or use of any information, product, or service described herein except as expressly agreed to in writing by Altera. Altera customers are advised to obtain the latest version of device specifications before relying on any published information and before placing orders for products or services.



## Chapter 1. Installing the EthernetBlaster II Communications Cable

Introduction	1-1
Supported Devices	1-1
Power Requirements	1-1
Software Requirements	1-2
Connections	1-2
Static and Dynamic IP Addressing	1-3
Cable Setup	1-3
Using the Network with Default Factory Settings for Remote Connections	1-4
Using the Network with Default Factory Settings if Your Network does not Support DHCP	1-6
Using the Default Factory Settings for a Direct Connection to a Computer	1-7
Configuring the EthernetBlaster II Hardware to Use Static IP Addressing	1-9
Configuring the EthernetBlaster II Hardware to Use Dynamic IP Addressing	1-10
Setting Up the EthernetBlaster II Hardware in the Quartus II Software	1-11
Removing the EthernetBlaster II Hardware from the Quartus II Software	1-12

## Chapter 2. EthernetBlaster II Communications Cable Administration

Introduction	2-1
Managing Passwords	2-1
Changing the Administrative Password	2-2
Changing the Quartus II Remote Connection Password	2-3
JTAG Clock Settings	2-3
Changing the JTAG Clock Frequency	2-4
Resetting the Hardware	2-5
Upgrading the Firmware	2-6

## Chapter 3. EthernetBlaster II Communications Cable Specifications

EthernetBlaster II Hardware Connections	3-1
Voltage Requirements	3-1
EthernetBlaster II Ethernet Jack Connection	3-2
EthernetBlaster Plug Connection	3-2
Circuit Board Header Connection	3-3
Operating Conditions	3-4

## Additional Information

Document Revision History	Info-1
How to Contact Altera	Info-1
Typographic Conventions	Info-1



Use the EthernetBlaster II communications cable to connect to a standard Ethernet network port with an RJ-45 connector to communicate with client systems. Using this Ethernet network, multiple users can access Altera® devices, bringing a new level of productivity to prototyping and debugging. Because design changes are downloaded directly to the device, prototyping is easy and you can accomplish multiple design iterations in quick succession.

## Introduction

The EthernetBlaster II cable communicates with client systems using the TCP/IP protocol and supports both static and dynamic IP addressing. You can plug the EthernetBlaster II communications cable into an existing 10/100/1000 Base-T Ethernet network to communicate with clients remotely or interface directly using a standard CAT 5 UTP 4-pair patch cable.

## Supported Devices

You can use the EthernetBlaster II communications cable to download configuration data to the following Altera devices:

- Stratix® series FPGAs
- Arria® series FPGAs
- Cyclone® series FPGAs
- MAX® series CPLDs

You can perform in-system programming of serial configuration devices, including EPCS1, EPCS4, EPCS16, EPCS64, and EPCS128 devices. In addition, the EthernetBlaster II communications cable supports target systems using 3.3-V LVTTTL/LVCMOS and single-ended I/O standards from 3.3 V down to 1.2 V.

## Power Requirements

The EthernetBlaster II communications cable requires between 1.2 V and 5.0 V from the target circuit board, and 12.0 volts direct current (VDC) (0.875 A) input power for the EthernetBlaster II  $V_{CCSUPPLY}$  (a 12.0 VDC wall transformer is supplied).

The EthernetBlaster II  $V_{CC(TARGET)}$  pin must be connected to the appropriate voltage for the device being programmed. The pull-up resistors on the target circuit board for the configuration and programming signals must be connected to the same power supply as the EthernetBlaster II  $V_{CC(TARGET)}$ .

## Software Requirements

- The EthernetBlaster II communications cable supports Windows and Linux Red Hat operating systems. You can obtain the specific operating system from the Quartus® II **Readme.txt** file or [http://www.altera.com/support/software/os\\_support/oss-index.html](http://www.altera.com/support/software/os_support/oss-index.html).

The EthernetBlaster II programming cable has been tested using Altera Corporation Design Suite (ACDS) tools 10.0 sp1 and later. The EthernetBlaster II communications cable also supports the following tools:

- Quartus II Programmer (for programming and configuration), which you can run within the Quartus II software or as a stand-alone version
- Quartus II SignalTap® II Logic Analyzer (for logic analysis), which you can run within the Quartus II software or as a stand-alone version
- Nios® II IDE (for software downloading and debugging)
- Nios II IDE Flash Programmer (for programming Flash devices)

## Connections

The EthernetBlaster II communications cable houses an Ethernet port on one side and a 10-pin female target port on the opposite side. The Ethernet port side contains an Ethernet port, a reset button, and a DC12 V jack. The target port side includes the 10-pin female target port and LED status light. The base of the cable includes the MAC address and host name. [Figure 1–1](#) shows the side and base views of the hardware.

**Figure 1–1. EthernetBlaster II Communications Cable Ethernet Port, Target Port, and Base Views**

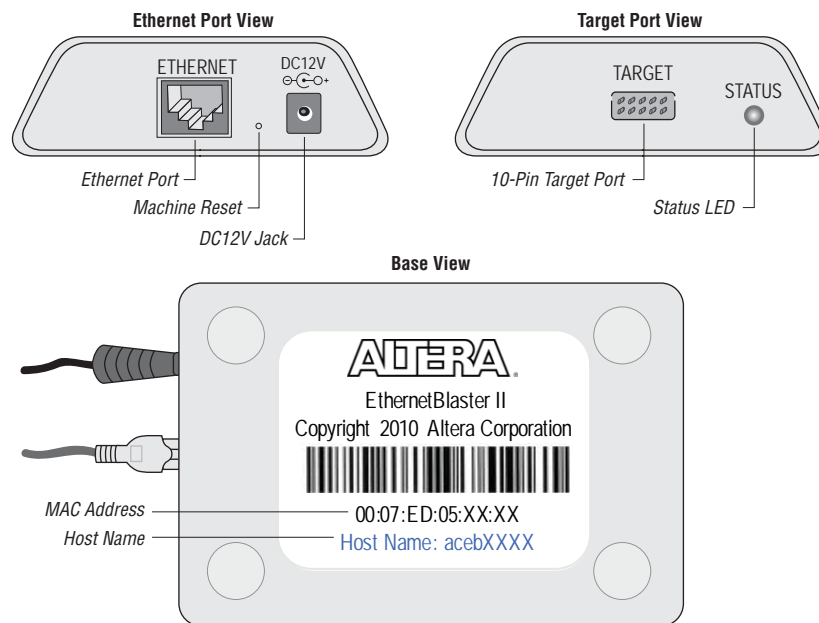

The status LED on the target port side of the cable displays the operating status of the EthernetBlaster II communications cable. [Table 1-1](#) lists each LED status mode.

**Table 1-1. Status LED Modes**

Status LED	Status Description
Yellow, blinking	Power on, reset
Green, blinking	Cable initialization
Green, steady	Cable ready, DHCP
Blue, blinking	Downloading data to the target PCB
Purple, blinking	Updating EthernetBlaster II firmware

## Static and Dynamic IP Addressing

The EthernetBlaster II communications cable supports both static IP and dynamic IP addressing, the latter by means of the dynamic host configuration protocol (DHCP). By default, the EthernetBlaster II cable is configured at the factory to use dynamic IP addressing. After power up, the cable attempts to obtain an IP address from your network DHCP server. The status LED is green and blinking while the network address is being obtained and the cable is initializing. This process may take up to two minutes.

After an IP address is obtained and the cable is ready to use, the status LED emits a steady green light. If the attempt to obtain an IP address is unsuccessful (the DHCP server may be down or absent), the cable switches to static IP addressing. The default IP address is configured to 192.168.0.50. If you use static IP addressing, you must configure your computer to an IP address in the same subnet as the cable to communicate with it. The default setting requires your address to be in the 192.168.0.X network domain.



Refer to your operating system manual or contact your network administrator to verify that your network supports DHCP services and for instruction on how to change your IP address.

To maintain your computer's IP address and change the EthernetBlaster II communications cable's default IP address, refer to [“Configuring the EthernetBlaster II Hardware to Use Static IP Addressing”](#) on page 1-9.

The EthernetBlaster II communications cable includes a self-hosted administrative web page, allowing you to configure various aspects of cable operation. The following section describes how to access this web page based on your mode of connection.

## Cable Setup

This section describes how to install and set up the EthernetBlaster II communications cable for device configuration or programming using the following setups:

- [“Using the Network with Default Factory Settings for Remote Connections”](#) on page 1-4
- [“Using the Default Factory Settings for a Direct Connection to a Computer”](#) on page 1-7

- “Configuring the EthernetBlaster II Hardware to Use Static IP Addressing” on page 1-9
- “Configuring the EthernetBlaster II Hardware to Use Dynamic IP Addressing” on page 1-10
- “Setting Up the EthernetBlaster II Hardware in the Quartus II Software” on page 1-11
- “Removing the EthernetBlaster II Hardware from the Quartus II Software” on page 1-12

 For plug and header dimensions, pin names, and operating conditions, refer to “EthernetBlaster II Communications Cable Specifications” on page 3-1.

## Using the Network with Default Factory Settings for Remote Connections

Use the following steps to connect remotely to the EthernetBlaster II communications cable:

 These steps assume no changes have been made to the default factory settings.

1. Power off the target circuit board.
2. Plug one end of a standard CAT 5 UTP 4-pair patch cable into the Ethernet jack on the EthernetBlaster II communications cable and the other end into a network port of a switch, router, or hub (Figure 1-2).

**Figure 1-2. Remote Connection Using the Network**

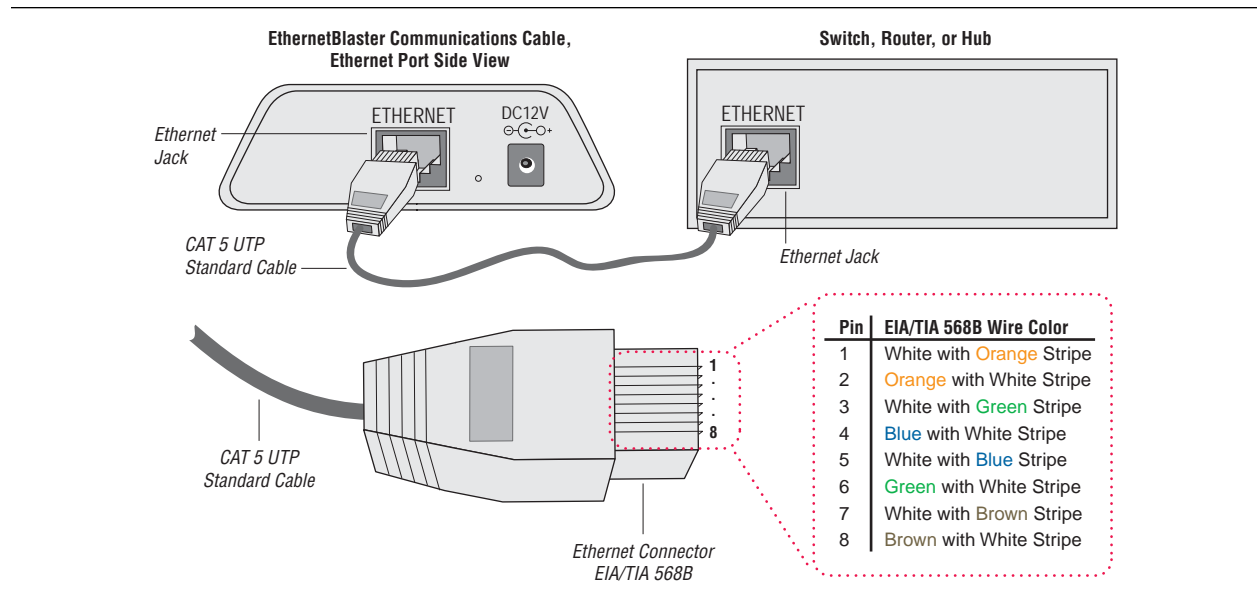

3. Connect the 10-pin female plug of the flexible, PCB-shielded cable labeled “BLASTER SIDE” to the 10-pin female target port on the Ethernet communications cable and the 10-pin female plug of the cable labeled “TARGET SIDE” to the 10-pin male header on the target circuit board (Figure 1-3).

**Figure 1-3. Connecting the EthernetBlaster II Communications Cable to the Target Circuit Board**

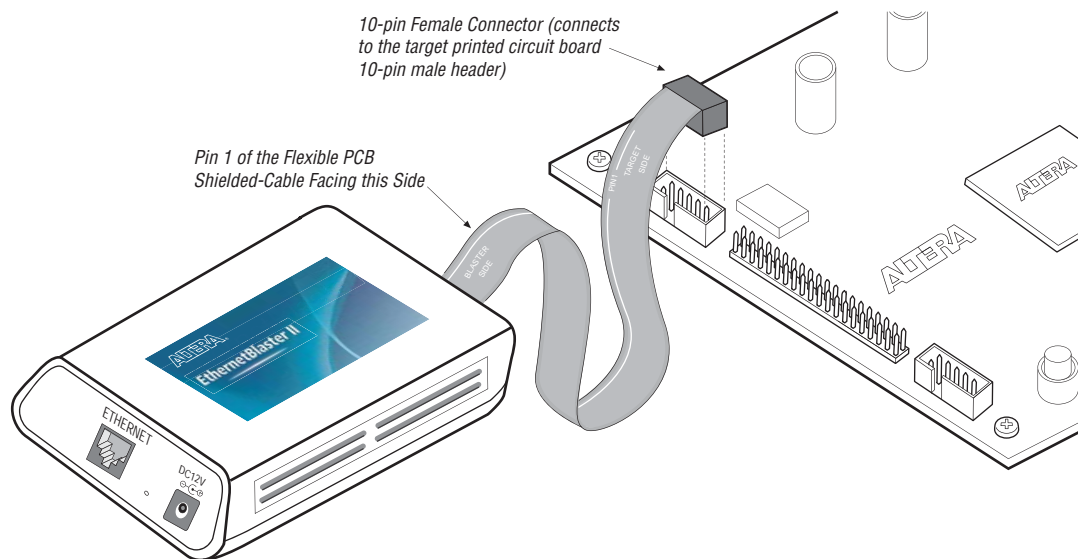

4. Plug the supplied 12.0-VDC wall transformer into a power outlet and then into the EthernetBlaster II communications cable.

 Always connect the network patch cable as instructed in Step 2 before connecting the power cord. This allows the EthernetBlaster II communications cable to obtain a DHCP address (if your network is configured to do so). Wait until the status LED emits a steady green light before completing the next steps.

5. Reconnect the power cable to the target circuit board to reapply power.
6. If your network supports DHCP, see Step 7 for configuration instructions. If your network does not support DHCP, see Step 1 (“Using the Network with Default Factory Settings if Your Network does not Support DHCP” on page 1-6) for configuration instructions.

- If your network supports DHCP, you can access the **EthernetBlaster II Configuration** administrative web page using a web browser with the hostname as the address. The hostname is located on the label on the base of the EthernetBlaster II communications cable (Figure 1-4).

**Figure 1-4. MAC Address and Host Name**

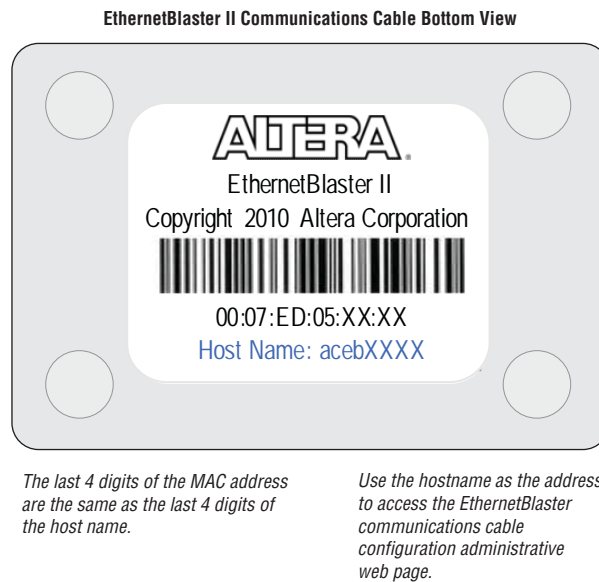

Browse to **http://<host name>** and specify the host name from the label on the base of your EthernetBlaster II communications cable. The **EthernetBlaster II login** window opens.

-  The last four digits of the MAC address match the last four digits of the host name on the label on the base of your EthernetBlaster II cable.

or

If you know the IP address obtained by the EthernetBlaster II communications cable, you can access the administrative web page by entering this address in your browser.

-  Refer to Step 2 for system configuration details.

### Using the Network with Default Factory Settings if Your Network does not Support DHCP

- If your network does not support DHCP, you must configure your computer to an address in the **192.168.0.X** network domain and then browse to **http://192.168.0.50**. Refer to Step 2 for system configuration details.

-  Refer to your operating system manual or contact your network administrator for instructions about how to change your IP address.

-  To maintain your computer's IP address and change the EthernetBlaster II communications cable default IP address, see ["Configuring the EthernetBlaster II Hardware to Use Static IP Addressing"](#) on page 1-9.

2. In the **EthernetBlaster II login** window, enter admin as the login and password as the default password. The **EthernetBlaster II Status** page opens, displaying the status of your EthernetBlaster II communications cable, including the current IP address (Figure 1-5).

**Figure 1-5. EthernetBlaster II Configuration Administrative Page**

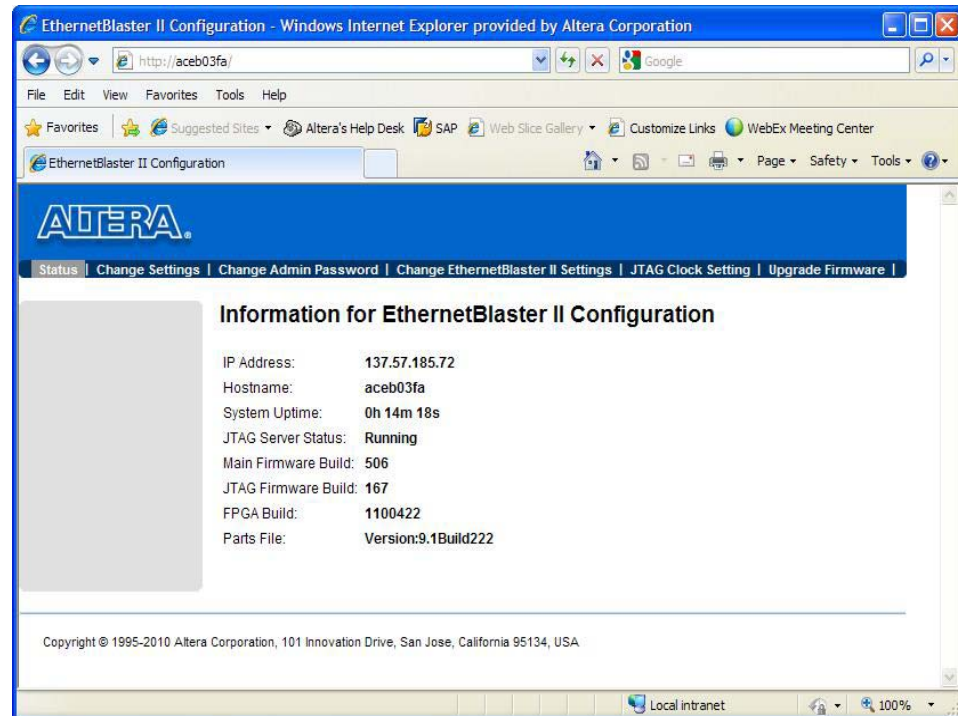

 To manage your password after the initial login, refer to “[Managing Passwords](#)” on page 2-1.

3. Proceed to “[Setting Up the EthernetBlaster II Hardware in the Quartus II Software](#)” on page 1-11 to set up your hardware in the Quartus II software.

## Using the Default Factory Settings for a Direct Connection to a Computer

You can connect the EthernetBlaster II communications cable directly to the network port of a computer. This setup does not allow remote users to access the EthernetBlaster II communications cable.

To connect the EthernetBlaster II communications cable directly to your system, use the following steps:

 These steps assume no changes have been made to the default factory settings.

1. Disconnect the power cable from the target circuit board.
2. Plug one end of a standard CAT 5 UTP 4-pair patch cable into the Ethernet jack on the EthernetBlaster II communications cable and the other end into your computer (Figure 1-6).

**Figure 1-6. Direct Connection to a Computer Using a Standard Cable**

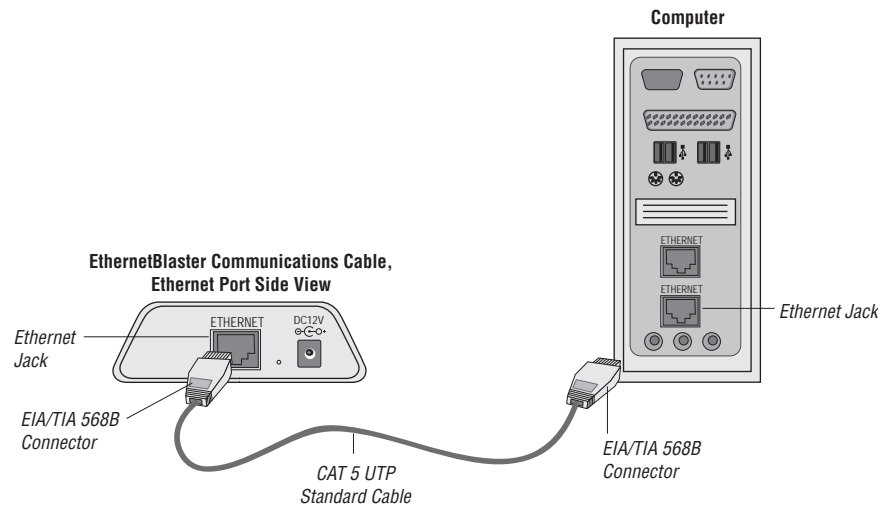

3. Connect the 10-pin female plug of the flexible, PCB-shielded cable labeled “BLASTER SIDE” to the 10-pin female target port on the Ethernet communications cable and the 10-pin female plug of the cable labeled “TARGET SIDE” to the 10-pin male header on the target circuit board (Figure 1-3 on page 1-5).
4. Plug the supplied 12.0-VDC wall transformer into a power outlet and then into the EthernetBlaster II communications cable.
5. Reconnect the power cable to the target circuit board to reapply power.
6. To access the **EthernetBlaster II Status** web page, configure your computer to an address in the **192.168.0.X** network domain and then browse to **http://192.168.0.50**. The **EthernetBlaster II login** window opens.

 Refer to your operating system manual or contact your network administrator for instruction about how to change your IP address.

To maintain your computer’s IP address and change the EthernetBlaster II communications cable default IP address, refer to the [“Configuring the EthernetBlaster II Hardware to Use Static IP Addressing”](#) section.

7. In the **EthernetBlaster II login** window, enter admin as the login and password as the default password. The **EthernetBlaster II Status** page opens displaying the status of your EthernetBlaster II communications cable including the current IP address (Figure 1-5 on page 1-7).

 To manage your password after initial login, refer to “[Managing Passwords](#)” on page 2-1.

8. To set up the EthernetBlaster II communications cable in the Quartus II software, refer to “[Setting Up the EthernetBlaster II Hardware in the Quartus II Software](#)” on page 1-11.

## Configuring the EthernetBlaster II Hardware to Use Static IP Addressing

By default, the EthernetBlaster II communications cable is factory configured to use dynamic IP addressing.

 Depending on your connection mode, this section assumes that you have completed the steps in “[Using the Network with Default Factory Settings for Remote Connections](#)” on page 1-4, or “[Using the Default Factory Settings for a Direct Connection to a Computer](#)” on page 1-7.

To configure your cable to use static IP addressing and complete your remote connection, use the following steps:

1. Open the **EthernetBlaster II Status** page.
2. Click the **Change Settings** tab and select **Static IP** from the **Connection Type** menu. Enter the desired IP address and other appropriate data in the settings fields (Figure 1-7).

 Contact your network administrator if you do not know the settings to complete the **Change Settings** page.

**Figure 1-7. EthernetBlaster II Change Settings Page**

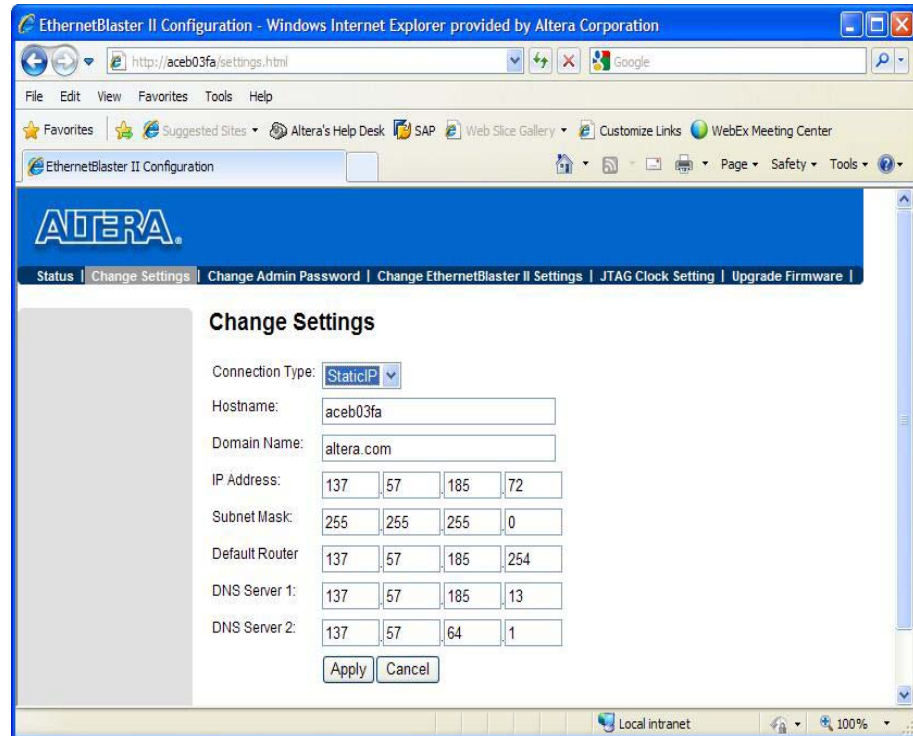

3. Click **Apply**. The EthernetBlaster II communications cable automatically restarts. When the status LED returns to a steady green state, the EthernetBlaster II communications cable has successfully restarted and can now be added to the Quartus II software. For more information, refer to [“Setting Up the EthernetBlaster II Hardware in the Quartus II Software”](#) on page 1-11.

## Configuring the EthernetBlaster II Hardware to Use Dynamic IP Addressing

To configure the EthernetBlaster II communications cable to use dynamic IP addressing, use the following steps:

 Depending on your connection mode, this section assumes that you have completed the steps in [“Using the Network with Default Factory Settings for Remote Connections”](#) on page 1-4 or [“Using the Default Factory Settings for a Direct Connection to a Computer”](#) on page 1-7.

1. Open the **EthernetBlaster II Status** page.
2. Click the **Change Settings** tab and select **DHCP** from the **Connection Type** menu ([Figure 1-7](#) on page 1-10).

 Contact your network administrator if you do not know the settings to complete the **Change Settings** page.

3. Click **Apply**. The EthernetBlaster II communications cable automatically restarts. When the status LED returns to a steady green state, the EthernetBlaster II communications cable has successfully restarted and can now be added to the Quartus II software. For more information, refer to the “[Setting Up the EthernetBlaster II Hardware in the Quartus II Software](#)” section.

## Setting Up the EthernetBlaster II Hardware in the Quartus II Software

To set up the EthernetBlaster II communications cable in the Quartus II software, use the following steps:

1. Start the Quartus II software.
2. From the Tools menu, choose **Programmer**.
3. Click **Hardware Setup**. The **Hardware Settings** tab of the **Hardware Setup** dialog box displays.
4. Click **Add Hardware**. The **Add Hardware** dialog box is displayed. Select **EthernetBlaster** and click **Auto Detect**.

 The server name list is automatically populated with the EthernetBlaster II communications cable detected on your subnet if you select **Auto Detect**. However, if the cable is not on your subnet, you must manually type the name or IP address of the EthernetBlaster II cable in the **Server Name** field of the **Add Hardware** dialog box. If you are using a direct connection to your computer, type 192.168.0.50 in the **Server Name** field.

5. Type the server password in the **Server password** field (“password” is the factory default), and click **OK**. **EthernetBlaster II** is now visible in the **Available hardware** items list of the **Hardware Setup** dialog box ([Figure 1-8](#)).

**Figure 1-8. Hardware Setup Dialog Box**

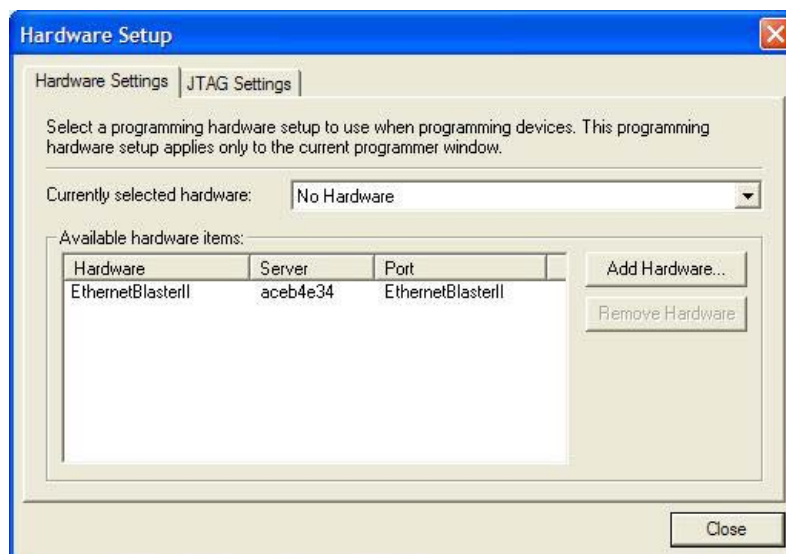

6. Click **Close** to close the **Hardware Setup** dialog box.
7. In the **Mode** list, select the desired mode (Programmer window). [Table 1-2](#) lists each mode.



The EthernetBlaster II communications cable supports Joint Test Action Group (JTAG), passive serial programming (PS), and active serial programming (AS).

**Table 1-2. Programming Modes**

Mode	Mode Description
JTAG	Programs or configures all Altera devices supported by the Quartus II software, excluding FLEX 6000 devices.
In-Socket Programming	Not supported by the EthernetBlaster II cable.
PS Programming	Configures all Altera devices supported by the Quartus II software, excluding the following devices: MAX II, MAX 3000, and MAX 7000, advanced configuration devices, and serial configuration devices.
AS Programming	Programs a single EPCS1, EPCS4, EPCS16, EPCS64, or EPCS128 serial configuration device.

## Removing the EthernetBlaster II Hardware from the Quartus II Software

Changes to the EthernetBlaster II communications cable setup, including password change and IP addressing mode change, require removing the cable from the Quartus II Programmer Hardware setup on client systems, followed by adding the cable back into the Quartus II Programmer Hardware setup.

To remove the EthernetBlaster II communications cable from the Quartus II Programmer hardware setup, use the following steps:

1. Start the Quartus II software.
2. From the Tools menu, choose **Programmer**.
3. Click **Hardware Setup**. The **Hardware Settings** tab of the **Hardware Setup** dialog box displays.
4. Click **JTAG Settings**. The **JTAG Settings** dialog box displays. Select the corresponding hostname or IP address of the EthernetBlaster II hardware to remove. Click **Remove Server**.



For instructions to add the EthernetBlaster II communications cable back into the Quartus II Programmer Hardware setup, refer to [“Setting Up the EthernetBlaster II Hardware in the Quartus II Software”](#) on page 1-11.



For more information about programming devices and creating secondary programming files, refer to the *Programming & Configuration* chapter of the [Introduction to Quartus II Manual](#).

For more information, refer to the Programming module of the Quartus II online tutorial. Also, refer to the following topics in the Quartus II online Help:

- Programming & Configuring Devices
  - Setting Up Programming Hardware
  - About Programming: Chain Description Files (.cdf)
  - Optional Programming Files



### Introduction

This chapter describes how to administer your EthernetBlaster II communications cable. This chapter includes the following information:

- [Managing Passwords](#)
  - [Changing the Administrative Password](#)
  - [Changing the Quartus II Remote Connection Password](#)
- [Resetting the Hardware](#)
- [Upgrading the Firmware](#)

### Managing Passwords

Networking allows multiple users in both remote and local locations to use the EthernetBlaster II communications cable, increasing the productivity in prototyping and debugging. However, because of this flexibility, it is necessary to limit and control user access of the provided password service in the EthernetBlaster II communications cable setup.

The EthernetBlaster II communications cable contains two types of passwords—an administrative password and a Quartus® II remote connection password.

- The administrative password is the master password used to enter the EthernetBlaster II administrative web page. If you know the administrative password, you have full control of settings and the ability to modify both the administrative password and the Quartus II remote connection password.
- The Quartus II remote connection password allows clients to add the EthernetBlaster II hardware to their Quartus II Programmer hardware setup. This password is used to control who has access to the EthernetBlaster II communications cable. However, they do not have access to the EthernetBlaster II administrative web page and cannot modify the settings or change passwords.

 When you change the Quartus II remote connection password, client systems using the EthernetBlaster II communications cable must remove the hardware from their Quartus II Programmer hardware setup. For more information, refer to [“Removing the EthernetBlaster II Hardware from the Quartus II Software”](#) on page 1–12. The hardware then must be added back into the Quartus II software. For more information, refer to [“Setting Up the EthernetBlaster II Hardware in the Quartus II Software”](#) on page 1–11.

## Changing the Administrative Password

To change the administrative password, use the following steps:

1. In your browser, open and log into the EthernetBlaster II administrative web page.

 For instructions about accessing the administrative web page using your specific connection, refer to “[Cable Setup](#)” on page 1–3.

2. Click the **Change Admin Password** tab ([Figure 2–1](#)).

**Figure 2–1. Change Admin Password Page**

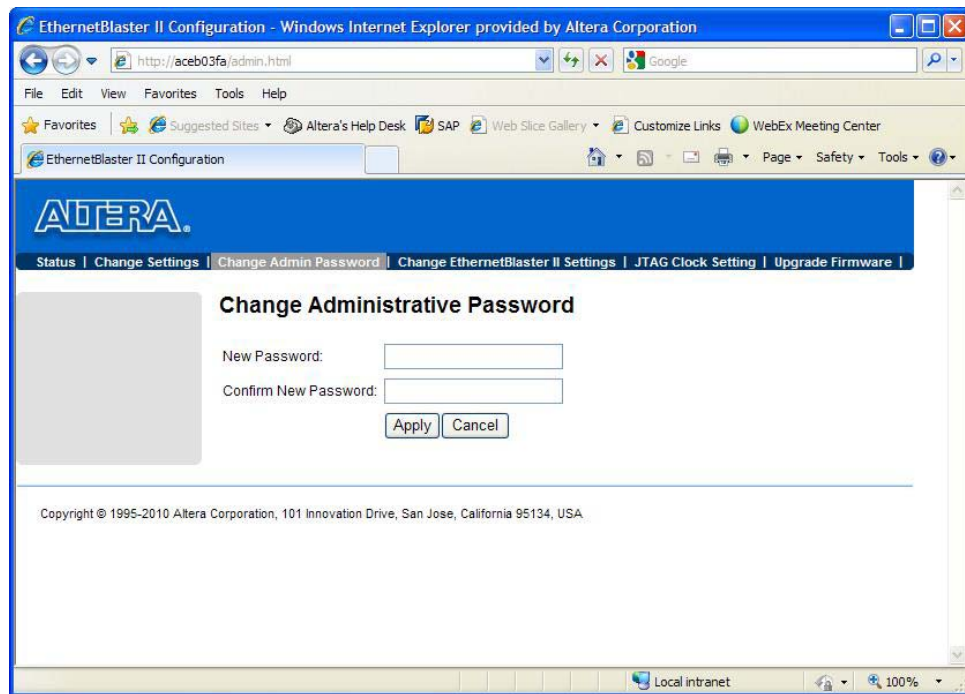

3. Enter the new administrative password in the **New Password** field and again in the **Confirm New Password** field. Click **Apply**.

The new password takes effect immediately when logging back into the administrative web page.

 The EthernetBlaster II communications cable does not restart when you reset the administrative password.

## Changing the Quartus II Remote Connection Password

To change the Quartus II remote connection password, use the following steps:

1. Open and log into the EthernetBlaster II administrative web page in your browser.

 For instructions about accessing the administrative web page using your specific connection, refer to “Cable Setup” on page 1–3.

2. Click the **Change EthernetBlaster II Settings** tab (Figure 2–2).

**Figure 2–2. Change the Quartus II Remote Connection Password Page**

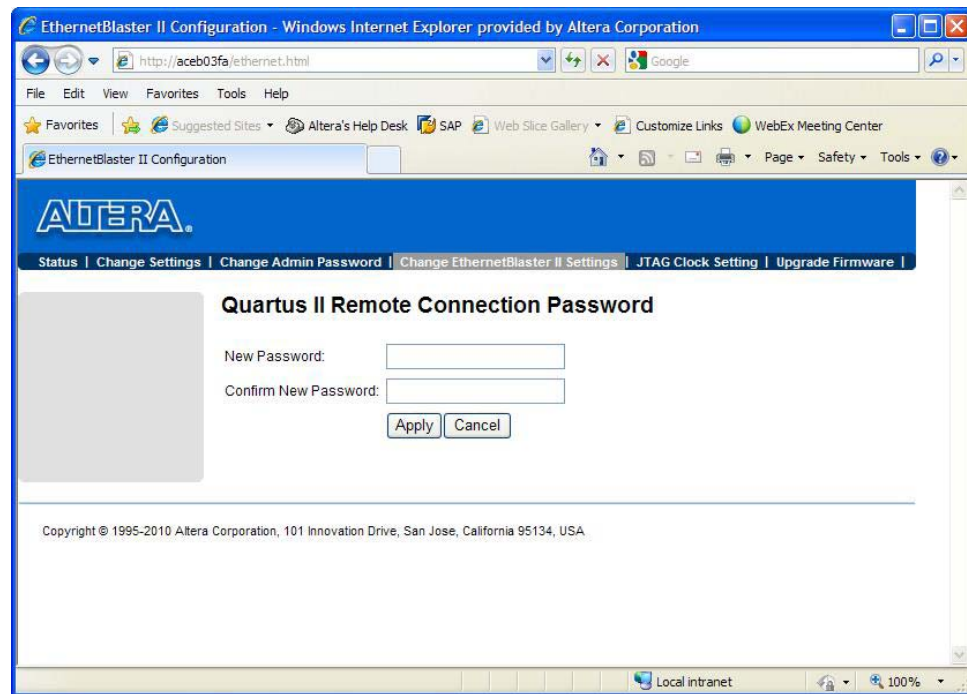

3. Enter the new Quartus II remote connection password in the **New Password** field and again in the **Confirm New Password** field. Click **Apply**.

The EthernetBlaster II communications cable restarts. When the status LED emits a steady green light, the EthernetBlaster II has successfully reset and the new password is effective.

## JTAG Clock Settings

The EthernetBlaster II communication cable has been designed to allow you to set the Joint Test Action Group (JTAG) clock (tCK) to something other than the default frequency of 8 MHz. Increasing this clock frequency results in faster configuration time in some modes, such as JTAG mode. However, Altera recommends keeping the JTAG clock at the default frequency.



Use caution when changing the JTAG clock setting from the default setting—even if a device supports a higher frequency, your board design also affects the maximum operating frequency of your cable.

## Changing the JTAG Clock Frequency

To change the JTAG clock frequency, use the following steps:

1. In your browser, open and log into the EthernetBlaster II administrative web page.
2. Click the **JTAG Clock Setting** tab (Figure 2-3).
  - a. The value shown in the **Select Clock Frequency** option is the JTAG clock frequency that the cable is currently set to.
3. To change the frequency, select a value from the drop down menu, then click **Apply**.
4. To return to the default value of **8 MHz**, either click **Default** or select **8 MHz** from the drop down menu and then click **Apply**.

**Figure 2-3. JTAG Clock Setting Page**

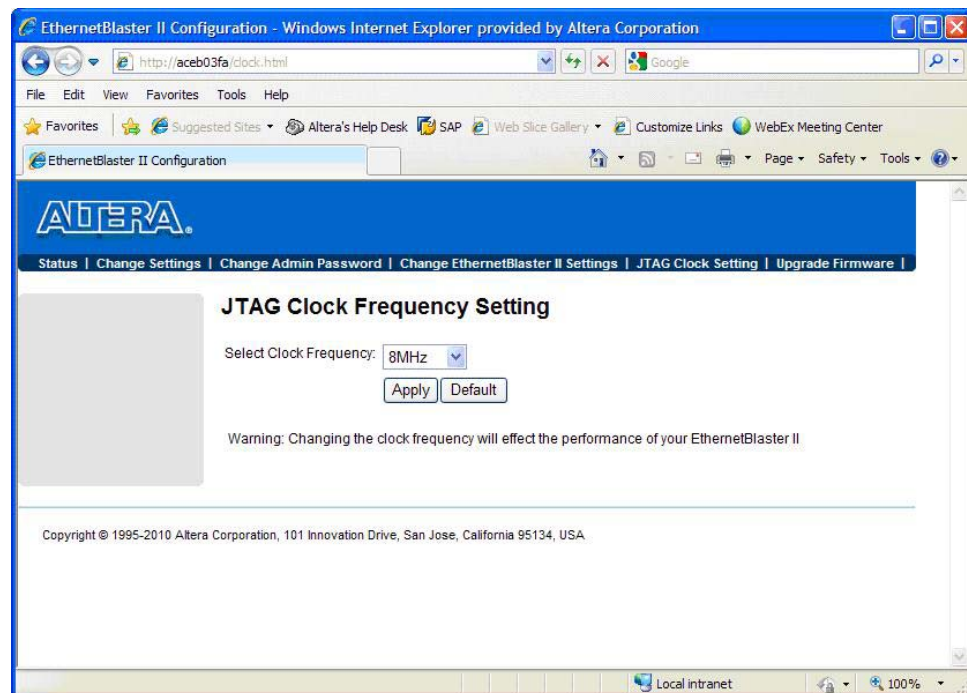

## Resetting the Hardware

The EthernetBlaster II communications cable reset button is located on the Ethernet port side of the hardware (Figure 2-4).

**Figure 2-4. Machine Reset Button**

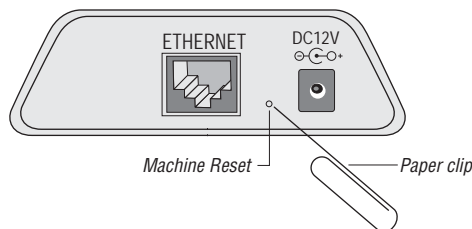

Use a small pointed object such as a paper clip to press the machine reset button to restart and reset all values to the default factory settings. Table 2-1 lists the factory default settings.

**Table 2-1. Default Factory Settings (Note 1)**

Default Factory Settings	Value
Connection Type	DHCP
Host name	acebXXXX
Domain name	Clear
Timeserver Name/IP	Clear
IP Address	192.168.0.50
Subnet Mask	255.255.255.0
Default Router	192.168.0.1
DNS Server 1	0.0.0.0
DNS Server 2	0.0.0.0
Administrative Password	password
Quartus II Remote Connection Password	password

**Note to Table 2-1:**

- (1) The host name and MAC address are located on the label on the base of your cable. The last four digits of the MAC address represent the “XXXX” in the host name.



When you reset the EthernetBlaster II, the existing client systems using passwords other than the factory default must remove the EthernetBlaster II hardware from their Quartus II Programmer Hardware Setup. For instructions about removing the EthernetBlaster II hardware, refer to “[Removing the EthernetBlaster II Hardware from the Quartus II Software](#)” on page 1-12. The hardware then must be added back into the Quartus II software. For more information, refer to “[Setting Up the EthernetBlaster II Hardware in the Quartus II Software](#)” on page 1-11.

## Upgrading the Firmware

The EthernetBlaster II communications cable has been designed to enable remote firmware upgrade when a new version of the firmware is available from Altera. New firmware may contain enhanced features, better performance, or bug fixes.



Do not turn off the EthernetBlaster II communications cable power when performing the firmware upgrade or severe damage will occur.

Firmware upgrades are included in Quartus II releases. Firmware upgrades and GPL source code updates are also available on the Altera website. For more information, go to <http://www.altera.com/support/software/drivers/dri-index.html>.

To upgrade the EthernetBlaster II communications firmware, use the following steps:

1. Open and log into the **EthernetBlaster II Configuration** administrative web page in your browser.



For instructions on accessing the administrative web page using your specific connection, refer to “[Cable Setup](#)” on page 1-3.

2. Click the **Upgrade Firmware** tab ([Figure 2-5](#)).

**Figure 2-5. Upgrade Firmware Page**

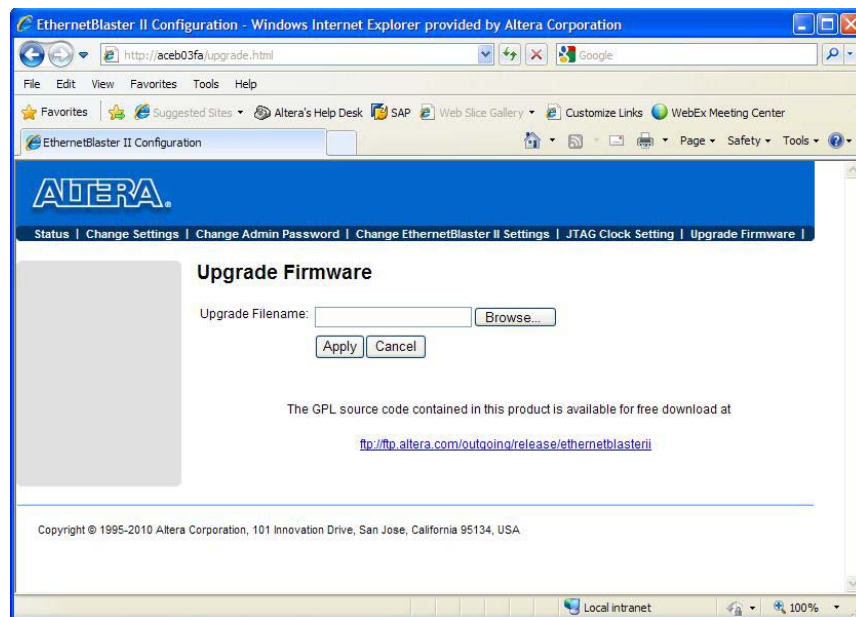

3. Click **Browse** and then locate and select the firmware file on your system. Click **Apply**.

The EthernetBlaster II communications cable restarts automatically after the firmware has been successfully upgraded. When the status LED returns to a steady green state, the EthernetBlaster II communications cable has restarted successfully.

This chapter provides comprehensive information about the EthernetBlaster II communications cable, including the following:

- “EthernetBlaster II Hardware Connections”
- “Operating Conditions” on page 3–4

## EthernetBlaster II Hardware Connections

The EthernetBlaster II cable connects to an Ethernet cable with an RJ45 jack to a 10/100/1000Base-T Ethernet hub/switch (using a straight 8-wire data cable) or a 10/100/1000Base-T Ethernet port of a PC (using a straight 8-wire or a crossover data cable). Depending on your connection (remote or direct), data is downloaded through the EthernetBlaster II communications cable to the circuit board using the connections described in this section.

### Voltage Requirements

You must connect the EthernetBlaster II  $V_{CC(TARGET)}$  pin to a specific voltage for the device being programmed. Connect pull-up resistors to the same power supply as the EthernetBlaster II  $V_{CC(TARGET)}$ . Table 3–1 lists the EthernetBlaster II  $V_{CC}$  voltage requirements.

**Table 3–1. EthernetBlaster II  $V_{CC(TARGET)}$  Pin Voltage Requirements**

Device Family	EthernetBlaster II $V_{CC}$ Voltage Required
MAX <sup>®</sup> II devices	As specified by $V_{CCIO}$ of Bank 1
MAX 7000AE and MAX 3000A devices	3.3 V
MAX 7000B device	2.5 V
Cyclone <sup>®</sup> IV devices	$V_{CCA}$
Cyclone III devices	As specified by $V_{CCA}$ or $V_{CCIO}$
Stratix <sup>®</sup> IV, Stratix III, Stratix II, Arria <sup>™</sup> II GX, and Arria GX devices	$V_{CCPD}$
Cyclone II, Cyclone devices	As specified by $V_{CCIO}$
EPC2 devices	3.3 V
EPC4, EPC8, and EPC16 devices	3.3 V
EPCS1, EPCS4, EPCS16, EPCS64, and EPCS128 devices	3.3 V
Stratix devices	As specified by $V_{CCSEL}$

## EthernetBlaster II Ethernet Jack Connection

The Ethernet cable Ethernet jack connects to the EthernetBlaster II communications cable Ethernet port. Figure 3-1 shows the Ethernet jack pin number designations.

**Figure 3-1. Ethernet Jack Pin Number Designations**

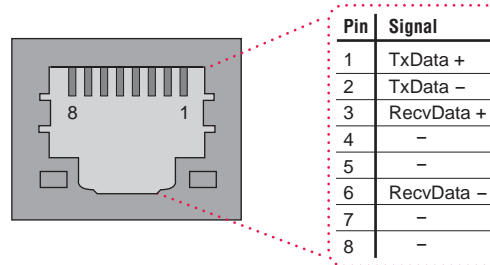

## EthernetBlaster Plug Connection

The 10-pin female plug connects to a 10-pin male header on the circuit board containing the target device (Figure 3-2).

**Figure 3-2. EthernetBlaster 10-Pin Female Target-Side Plug Dimensions**

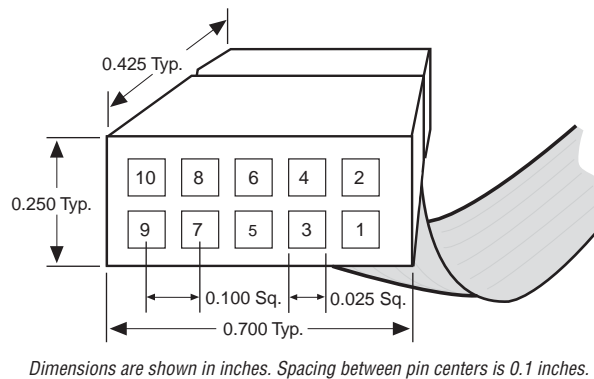

Table 3-2 lists the 10-pin female plug pin names and the corresponding programming mode.

**Table 3-2. EthernetBlaster Female Plug Signal Names and Programming Modes (Part 1 of 2)**

Pin	AS Mode		PS Mode		JTAG Mode	
	Signal Name	Description	Signal Name	Description	Signal Name	Description
1	DCLK	Clock signal	DCLK	Clock signal	TCK	Clock signal
2	GND	Signal ground	GND	Signal ground	GND	Signal ground
3	CONF_DONE	Configuration done	CONF_DONE	Configuration done	TDO	Data from device
4	VCC ( TARGET )	Target power supply	VCC ( TARGET )	Target power supply	VCC( TARGET )	Target power supply
5	nCONFIG	Configuration control	nCONFIG	Configuration control	TMS	JTAG state machine control

**Table 3-2. EthernetBlaster Female Plug Signal Names and Programming Modes (Part 2 of 2)**

Pin	AS Mode		PS Mode		JTAG Mode	
	Signal Name	Description	Signal Name	Description	Signal Name	Description
6	nCE	Cyclone chip enable	–	No connect	–	No connect
7	DATAOUT	Active serial data out	nSTATUS	Configuration status	–	No connect
8	nCS	Serial configuration device chip select	–	No connect	–	No connect
9	ASDI	Active serial data in	DATA0	Data to device	TDI	Data to device
10	GND	Signal ground	GND	Signal ground	GND	Signal ground

 The circuit board must supply  $V_{CC(TARGET)}$  and ground to the EthernetBlaster II cable for the I/O drivers.

## Circuit Board Header Connection

The circuit board's 10-pin male header, which connects to the EthernetBlaster II cable's 10-pin female plug, has two rows of five pins. These pins are connected to the device's programming or configuration pins. Figure 3-3 shows the dimensions of a typical 10-pin male header.

 Although you can use a 10-pin surface mount header for the Joint Test Action Group (JTAG), active serial (AS), or passive serial (PS) download cable, Altera recommends using a through-hole connector because of the repeated insertion and removal force needed.

**Figure 3-3. 10-Pin Male Header Dimensions**

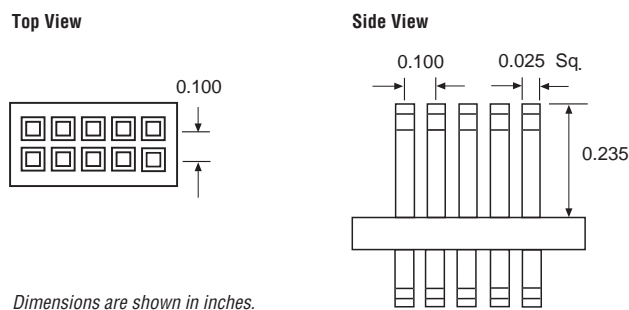

## Operating Conditions

Table 3-3 through Table 3-5 list the maximum ratings, recommended operating conditions, and DC operating conditions for the EthernetBlaster II communication cable.

Table 3-3 lists the EthernetBlaster II cable absolute maximum ratings.

**Table 3-3. EthernetBlaster II Cable Absolute Maximum Ratings**

Symbol	Parameter	Conditions	Min	Max	Unit
$V_{CC(TARGET)}$	Target supply voltage	With respect to ground	-0.3	5.5	V
$V_{CC(SYS)}$	System supply voltage	With respect to ground	—	36.0	V
$I_I$	Input current	TDO or dataout	-10.0	10.0	mA
$I_O$	Output current	TCK, TMS, TDI, nCS, nCE	-10.0	10.0	mA

Table 3-4 lists the EthernetBlaster II Cable recommended operating conditions.

**Table 3-4. EthernetBlaster II Cable Recommended Operating Conditions**

Symbol	Parameter	Conditions	Min	Max	Unit
$V_{CC(TARGET)}$	Target supply voltage, 5.0-V operation	—	4.75	5.25	V
	Target supply voltage, 3.3-V operation	—	3.0	3.6	V
	Target supply voltage, 2.5-V operation	—	2.375	2.625	V
	Target supply voltage, 1.8-V operation	—	1.71	1.89	V
	Target supply voltage, 1.5-V operation	—	1.43	1.57	V
	Target supply voltage, 1.2-V operation	—	1.1	1.26	V

Table 3-5 lists the EthernetBlaster II Cable DC operating conditions.

**Table 3-5. EthernetBlaster II Cable DC Operating Conditions (Part 1 of 2)**

Symbol	Parameter	Conditions	Min	Max	Unit
$V_{IH}$	High-level input voltage	$V_{CC(TARGET)} < 0V = 3.3 V$	$V_{CC(TARGET)} - 0.2$	—	V
	High-level input voltage	$V_{CC(TARGET)} > 3.3 V$	3.1	—	V
$V_{IL}$	Low-level input voltage	—	—	0.15	V
$V_{OH}$	5.0-V high-level output voltage	$V_{CC(TARGET)} = 4.5 V, IOH = 20 mA$	3.3	—	V
	3.3-V high-level output voltage	$V_{CC(TARGET)} = 3.0 V, IOH = 20 mA$	2.0	—	V
	2.5-V high-level output voltage	$V_{CC(TARGET)} = 2.375 V, IOH = 20 mA$	2.0	—	V
	1.8-V high-level output voltage	$V_{CC(TARGET)} = 1.71 V, IOH = 20 mA$	0.45	—	V
	1.5-V high-level output voltage	$V_{CC(TARGET)} = 1.43 V, IOH = 20 mA$	0.75	—	V
	1.2-V high-level output voltage	$V_{CC(TARGET)} = 1.14 V, IOH = 20 mA$	0.75	—	V

**Table 3-5. EthernetBlaster II Cable DC Operating Conditions (Part 2 of 2)**

Symbol	Parameter	Conditions	Min	Max	Unit
$V_{OL}$	5.0-V low-level output voltage	$V_{CC(TARGET)} = 5.5\text{ V}, I_{OL} = 1\text{ mA}$	—	0.4	V
	3.3-V low-level output voltage	$V_{CC(TARGET)} = 3.6\text{ V}, I_{OL} = 1\text{ mA}$	—	0.4	V
	2.5-V low-level output voltage	$V_{CC(TARGET)} = 2.625\text{ V}, I_{OL} = 1\text{ mA}$	—	0.4	V
	1.8-V low-level output voltage	$V_{CC(TARGET)} = 1.89\text{ V}, I_{OL} = 1\text{ mA}$	—	0.45	V
	1.5-V low-level output voltage	$V_{CC(TARGET)} = 1.57\text{ V}, I_{OL} = 1\text{ mA}$	—	0.25	V
	1.2-V low-level output voltage	$V_{CC(TARGET)} = 1.26\text{ V}, I_{OL} = 2\text{ mA}$	—	0.25	V
$I_{CC(SYS)}$	Operating current (No Load)	Typical $I_{CC(SYS)} = 350\text{ mA} @ V_{CC(SYS)} = 12\text{ V}$	—	700	mA



This chapter provides additional information about this user guide and Altera.

## Document Revision History

The following table lists the revision history for this user guide.

Date	Version	Changes
August 2010	1.0	Initial release.

## How to Contact Altera

To locate the most up-to-date information about Altera products, refer to the following table.

Contact (1)	Contact Method	Address
Technical support	Website	<a href="http://www.altera.com/support">www.altera.com/support</a>
Technical training	Website	<a href="http://www.altera.com/training">www.altera.com/training</a>
	Email	<a href="mailto:custrain@altera.com">custrain@altera.com</a>
Product literature	Website	<a href="http://www.altera.com/literature">www.altera.com/literature</a>
Non-technical support (General) (Software Licensing)	Email	<a href="mailto:nacomp@altera.com">nacomp@altera.com</a>
	Email	<a href="mailto:authorization@altera.com">authorization@altera.com</a>









**Note to Table:**

(1) You can also contact your local Altera sales office or sales representative.

## Typographic Conventions

The following table shows the typographic conventions this document uses.

Visual Cue	Meaning
<b>Bold Type with Initial Capital Letters</b>	Indicate command names, dialog box titles, dialog box options, and other GUI labels. For example, <b>Save As</b> dialog box. For GUI elements, capitalization matches the GUI.
<b>bold type</b>	Indicates directory names, project names, disk drive names, file names, file name extensions, software utility names, and GUI labels. For example, <b>\qdesigns</b> directory, <b>D:</b> drive, and <b>chiptrip.gdf</b> file.
<i>Italic Type with Initial Capital Letters</i>	Indicate document titles. For example, <i>Stratix IV Design Guidelines</i> .
<i>italic type</i>	Indicates variables. For example, $n + 1$ . Variable names are enclosed in angle brackets (< >). For example, <file name> and <project name>.pdf file.
Initial Capital Letters	Indicate keyboard keys and menu names. For example, the Delete key and the Options menu.

Visual Cue	Meaning
"Subheading Title"	Quotation marks indicate references to sections within a document and titles of Quartus II Help topics. For example, "Typographic Conventions."
Courier type	Indicates signal, port, register, bit, block, and primitive names. For example, <code>data1</code> , <code>tdi</code> , and <code>input</code> . The suffix <code>n</code> denotes an active-low signal. For example, <code>resetn</code> . Indicates command line commands and anything that must be typed exactly as it appears. For example, <code>c:\qdesigns\tutorial\chiptrip.gdf</code> . Also indicates sections of an actual file, such as a Report File, references to parts of files (for example, the AHDL keyword <code>SUBDESIGN</code> ), and logic function names (for example, <code>TRI</code> ).
	An angled arrow instructs you to press the Enter key.
1., 2., 3., and a., b., c., and so on	Numbered steps indicate a list of items when the sequence of the items is important, such as the steps listed in a procedure.
	Bullets indicate a list of items when the sequence of the items is not important.
	The hand points to information that requires special attention.
	A question mark directs you to a software help system with related information.
	The feet direct you to another document or website with related information.
	A caution calls attention to a condition or possible situation that can damage or destroy the product or your work.
	A warning calls attention to a condition or possible situation that can cause you injury.
	The envelope links to the <a href="#">Email Subscription Management Center</a> page of the Altera website, where you can sign up to receive update notifications for Altera documents.